

Thru Hole Transformer

SPECIFICATIONS : **56 Kbps**

ELECTRICAL :

IMPEDANCE : PRI. & SEC.= 600 OHMS EACH (REF.)

DESIGNED TO REFLECT : 600 OHMS \pm 3% ON PRI. WITH
374 OHMS LOAD ON SEC. @ 1KHz, 1Vrms

D.C. RESISTANCE : PRI. = 108 OHMS \pm 10% @ 20°C
SEC. = 120 OHMS \pm 10%

TURN RATIO : (PRI. : SEC.) = 1 : 1 \pm 1%

D.C. CURRENT : NONE

INDUCTANCE : 15 H MIN. (TYP. 20H) @ 200Hz, 1Vrms ON PARALLEL

INSERTION LOSS : 2.1 dB MAX. @ 1KHz, 1Vrms

FREQUENCY RESPONSE : \pm 0.1 dB @ 300Hz - 4KHz

RETURN LOSS : 25 dB MIN. @ 200Hz - 3.5KHz

TOTAL HARMONIC DISTORTION : -82 dB MAX. , 600Hz, -10dBm
-80 dB MAX. , 300Hz, -10dBm
-75 dB MAX. , 150Hz, -10dBm

LONGITUDINAL BALANCE : 60 dB MIN. , 200Hz - 1KHz
40 dB MIN. , 1KHz - 4KHz

HI-POT TEST : 1.25 KVAC MIN. BETWEEN PRI. & SEC. 1mA FOR 2 SECONDS

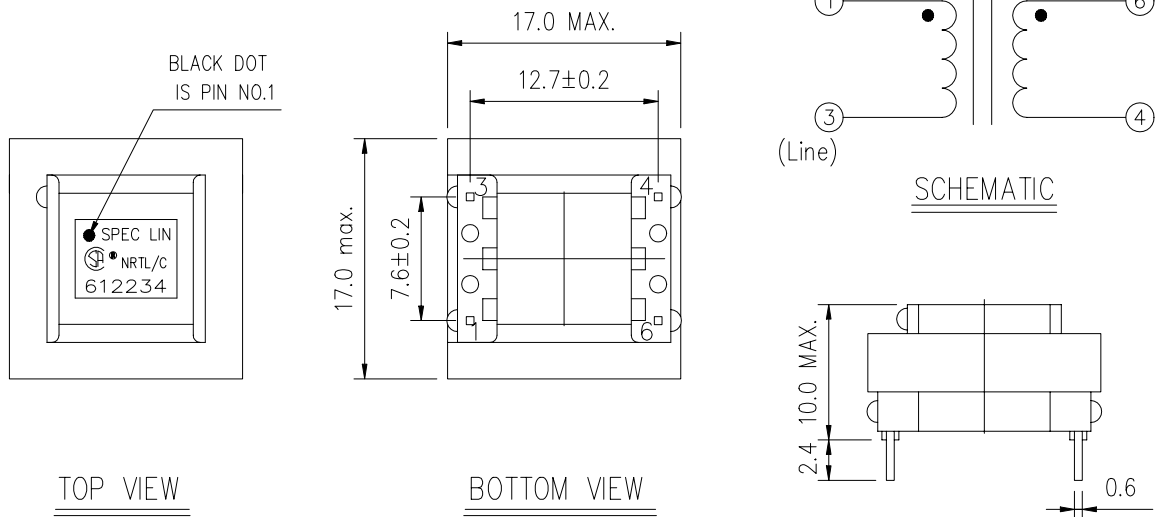

SPEC LIN ENTERPRISE CO. LTD.

2F, No.6, ALLEY 17, LANE 42, CHUNG HSING N.ST.
SAN CHUNG CITY, TAIPEI, TAIWAN
TEL: 886-2-29991394 FAX: 886-2-22781629

AGENCY NO.

UL NO. : E181559

CSA NO. : LR107869

ISO 9002: 036809750

DRAWING NO.

612234

UNITS
mm

SHEET
1 OF 1

